

VC100SI IR STEREO VOLUME CONTROL

Installation Instructions

PLEASE NOTE: Installation should be performed by qualified service personnel, and must meet all local building codes.

STEP 1: DETERMINE & SET IMPEDANCE MULTIPLICATION SETTINGS

- 1.) Count the total number of pairs of 4 Ohm and 8 Ohm speakers you are connecting.
NOTE: If you have 6 Ohm speakers count them as 4 Ohm speakers.
- 2.) Determine if the amplifier can support a 4 Ohm or 8 Ohm speaker load. You can typically find this information in the amplifier owner's manual.
- 3.) Determine the correct impedance match jumper position from the charts shown below. See Figure 2 if your amplifier can handle a 4 Ohm speaker load. See Figure 3 if your amplifier can handle an 8 Ohm speaker load.
- 4.) Set the impedance match jumpers on all of the volume controls in the system to the same position (1X, 2X, 4X, 8X or 16X). See Figure 1.

WARNING!

Make sure to set the impedance match jumpers on all of the volume controls in the system to the same position, otherwise serious amplifier damage may occur.

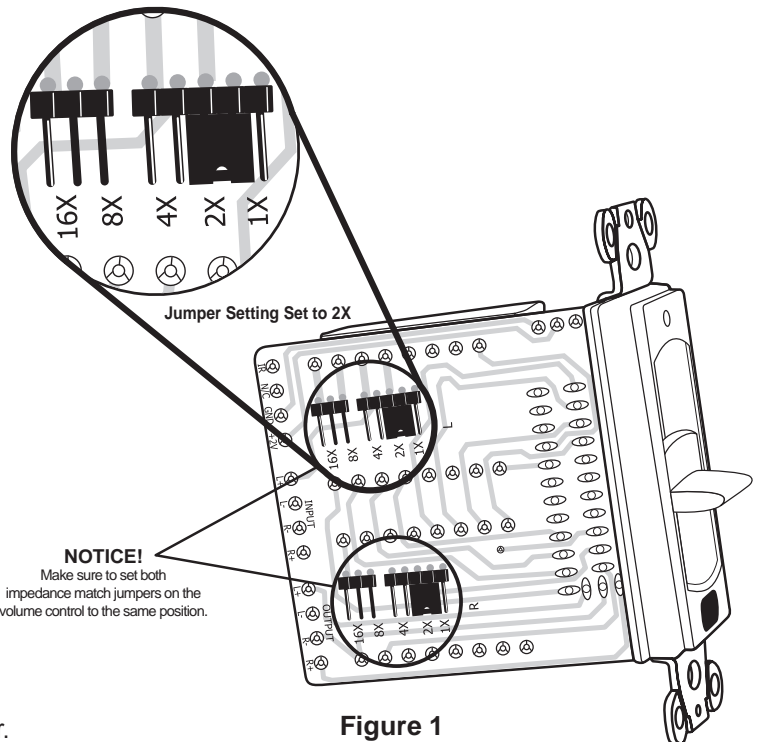

Figure 1

AMPLIFIER IS STABLE TO 4 OHMS Number of pairs of 8 Ohm speakers

Number of pairs of 4 Ohm speakers	Number of pairs of 8 Ohm speakers																
	0	1	2	3	4	5	6	7	8	9	10	11	12	13	14	15	16
0	1x																
1		2x		4x													
2																	
3																	
4																	
5																	
6																	
7																	
8																	

Figure 2

AMPLIFIER IS STABLE TO 8 OHMS Number of pairs of 8 Ohm speakers

Number of pairs of 4 Ohm speakers	Number of pairs of 8 Ohm speakers																
	0	1	2	3	4	5	6	7	8	9	10	11	12	13	14	15	16
0	1x		2x		4x												
1		2x		4x													
2			4x		8x												
3																	
4																	
5																	
6																	
7																	
8																	

Figure 3

Destination Audio does not recommend installing more than 8 volume controls to one amplifier, or installing more than two (2) 8 Ohm speakers per channel on each volume control without additional impedance protection.

PLEASE NOTE: High impedance match setting's affect on volume

Setting the impedance match jumper switch higher than 1X will yield less power per pair of speakers. For example: An amplifier rated at 100 Watts per channel RMS into 8 Ohms is to be used for 8 pairs of speakers. In order to accommodate 8 pairs of 8 Ohm speakers, an 8X impedance match setting must be used. Therefore, this will limit the 100 Watts of power to 12.5 Watts for each speaker pair, or one-eighth of the amplifier's power.

For assistance, please call 800-543-2205 or check <http://www.destinationaudio.com> for updated instructions.

STEP 2: CHANGE TRIM COLOR (optional)

This Destination Audio Volume Control comes with four different color scheme trim kits: White, Almond, Bone, Black and Brown. The Volume Control comes with the White trim scheme, but you can change the color scheme by following these steps:

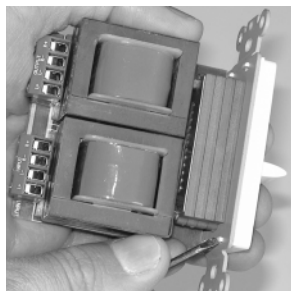

1.) Use a small screwdriver or other similar tool to gently push the plastic tabs through the metal back plate.

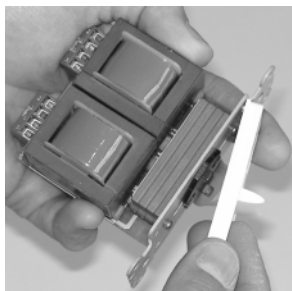

2.) Gently pry the faceplate off of the metal back plate.

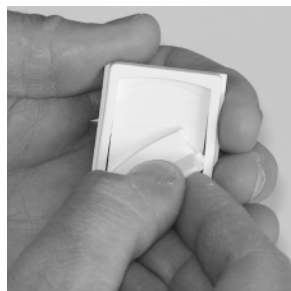

3.) Remove the slide knob by twisting to the left or right.

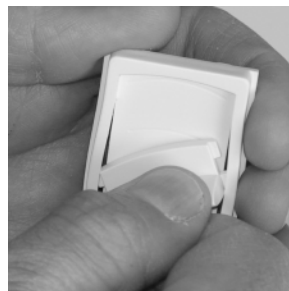

4.) Put the new slide knob into the new faceplate by twisting to the left or right. Some bending is normal and is to be expected.



5.) Once the new slide knob is in the new faceplate, check to make sure it slides easily in the slot.

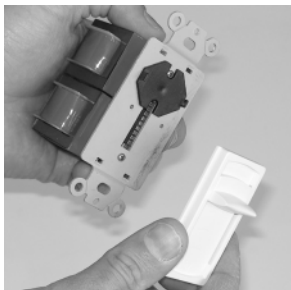

6.) Set the volume control's level to maximum and move the slide knob to the top of the faceplate.

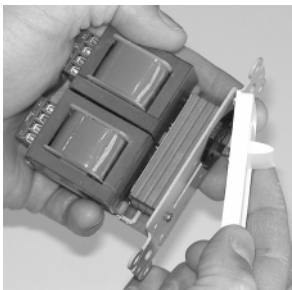

7.) Align the faceplate tabs in the top two holes in the metal back plate. Then, make sure the other two plastic tabs align with the other two holes in the metal back plate.

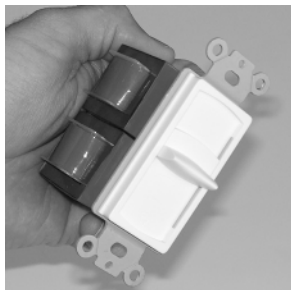

8.) Gently (but firmly) press the new plastic faceplate onto the metal back plate. Then, check for smooth and easy operation.

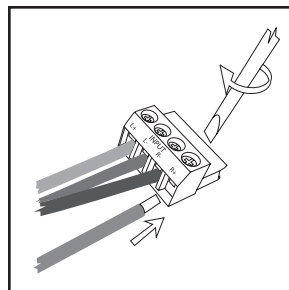

Figure 4

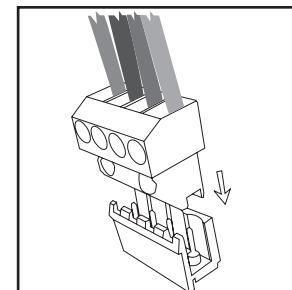

Figure 5

STEP 3: INSTALLATION

- Strip $\frac{1}{4}$ " to $\frac{3}{8}$ " of the insulation from the end of each wire and tightly twist the end of each wire until no frayed ends remain.
- Insert each wire from the amplifier into the proper L+, L-, R+ or R- input terminal and use a small screwdriver to tighten each screw; see Figure 4. Make sure to observe proper polarity for each connection.
- Insert each wire from the speakers into the proper L+, L-, R+ or R- output terminal and use a small screwdriver to tighten each screw; see Figure 4. Make sure to observe proper polarity for each connection.
- Insert both input and output terminals into the proper locations on the volume control; see Figure 5.
- Wire the power in terminal to the power out terminal on the IR connector block; see Figure 6.
- Insert the volume control into the junction box and use the two longer screws to mount the volume control into the junction box.
- Place the outer trim ring onto the volume control face and use the two shorter screws to affix the outer trim ring to the volume control.

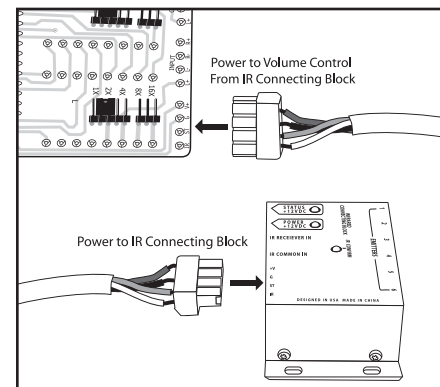

Figure 6

Technical Specifications

Audio Power Handling: 40 Watts continuous (RMS)/100 Watts maximum

Frequency Response: 25Hz–20kHz

Switch: 12 position slide (including 'Off')

Wiring Requirements: 14-16 gauge wire. *Input & Output (separate):* Two separate two-conductor speaker wires, or 1 four-conductor speaker wire.

Mounting: Fits most standard single-gang junction boxes

Impedance Multiplication: 1X, 2X, 4X, 8X and 16X

Unit Dimensions: $1\frac{3}{4}$ " W x $2\frac{3}{4}$ " H x $2\frac{19}{64}$ " D

Faceplate Dimensions: $2\frac{3}{4}$ " W x $4\frac{1}{2}$ " H

Warranty: 25 Years

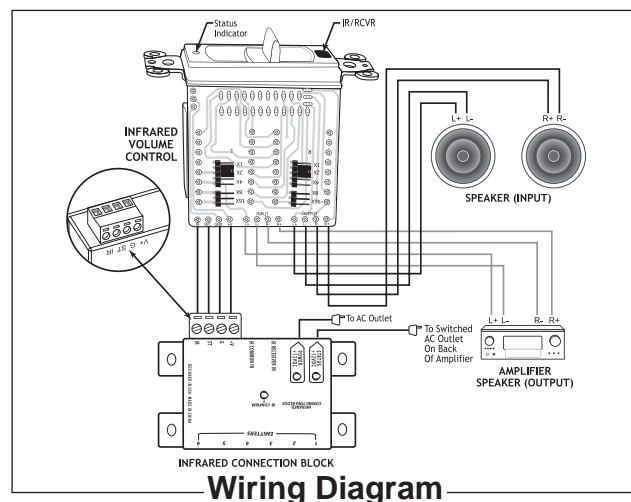

Wiring Diagram